

Industrial Bar Code Scanners



APPLICATIONS

- Automated warehousing
- Reading on forklift trucks
- Picking systems
- Automated shop floor

ADVANTAGES

- Extended reading range from 250 to 2000 mm thanks to the "2-step" mechanically adjustable focus system
- DIGITECH™ technology permits full software control over signal processing parameters. Scanner setup can therefore be optimized simply loading optimized software recipes, thus enabling excellent performance in all reading conditions
- ACR4™ reconstruction technology increases the maximum tilt angle and overall read rate on damaged barcodes
- Available with integrated software programmable Oscillating Mirror and built-in connectivity to Ethernet, Profibus and DeviceNet
- Easy and simple configuration thanks to Genius™ multi-language software tool

HIGHLIGHTS

- Good reading performance on very low contrast bar codes
- Focus adjustable optics
- Reading range from 250 to 2000mm
- ACR4[™] reconstruction technology improves reading of damaged barcodes
- DIGITECH[™] technology enables excellent reading performance
- Linear and integrated Oscillating Mirror versions
- Built-in connectivity to Ethernet / Profibus / DeviceNet
- Display and keyboard for scanner monitoring and diagnostics

GENERAL DESCRIPTION

DS6300 scanner is designed to offer a complete modular solution in terms of reading performance, built-in connectivity, ease of use and maintenance. With DS6300, Datalogic Automation provides mid-range industrial bar code readers with top class performance.

DS6300 is therefore the optimal solution for a wide range of manufacturing applications both in the automated shop floor and in the automated warehousing.

DS6300 features a practical display with keyboard that increases the scanner's ease of use by showing barcode data read (local echo), statistics and diagnostic information. Moreover, it offers built-in connectivity to Ethernet, DeviceNet and Profibus networks.



READING DIAGRAMS

DS6300-100-0XX

Resolution: 0.20 mm/8 mils

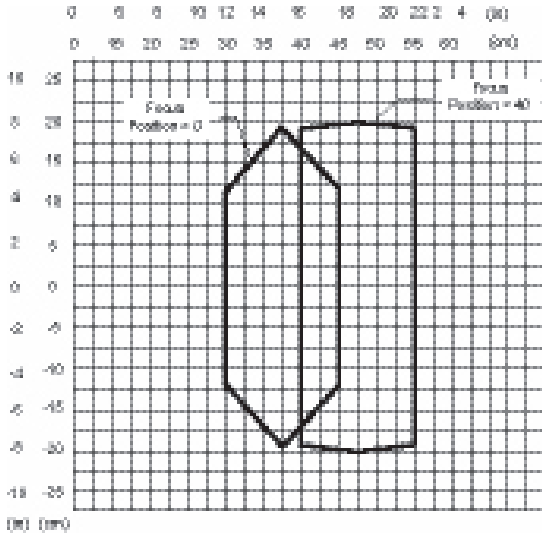

CONDITIONS

Code = Interleaved 2/5 or Code 39
 PCS = 0.90
 Pitch angle = 0°
 Skew angle = 10° - 20°
 Tilt angle = 0°

DS6300-100-0XX

Resolution: 0.30 mm/12 mils

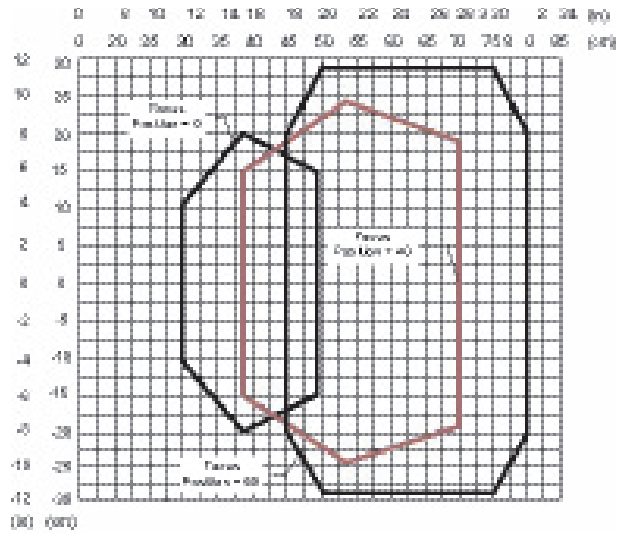

CONDITIONS

Code = Interleaved 2/5 or Code 39
 PCS = 0.90
 Pitch angle = 0°
 Skew angle = 10° - 20°
 Tilt angle = 0°

DS6300-100-0XX

Resolution: 0.38 mm/15 mils

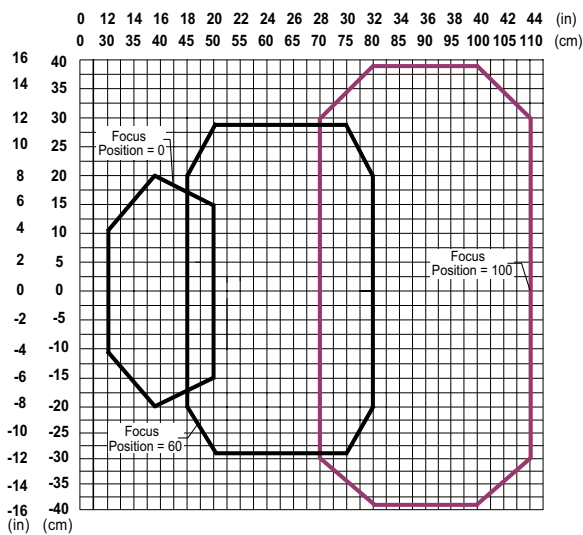

CONDITIONS

Code = Interleaved 2/5 or Code 39
 PCS = 0.90
 Pitch angle = 0°
 Skew angle = 10° - 20°
 Tilt angle = 0°

DS6300-100-0XX

Resolution: 0.50 mm/20 mils

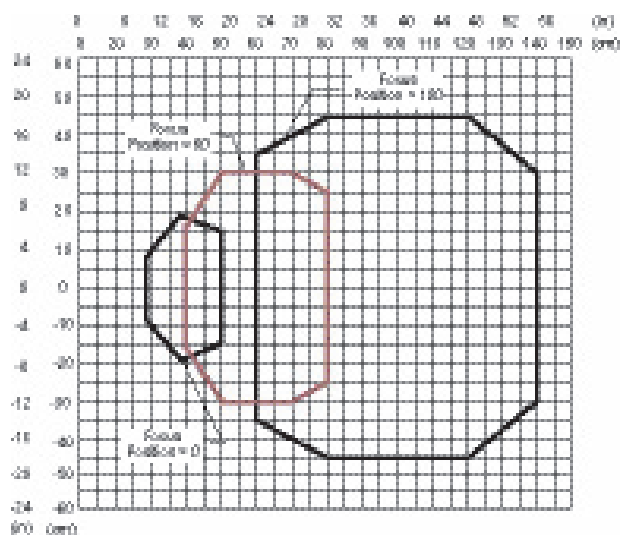

CONDITIONS

Code = Interleaved 2/5 or Code 39
 PCS = 0.90
 Pitch angle = 0°
 Skew angle = 10° - 20°
 Tilt angle = 0°

READING DIAGRAMS

DS6300-105-0XX (Oscillating Mirror)
Resolution: 0.20 mm/8 mils

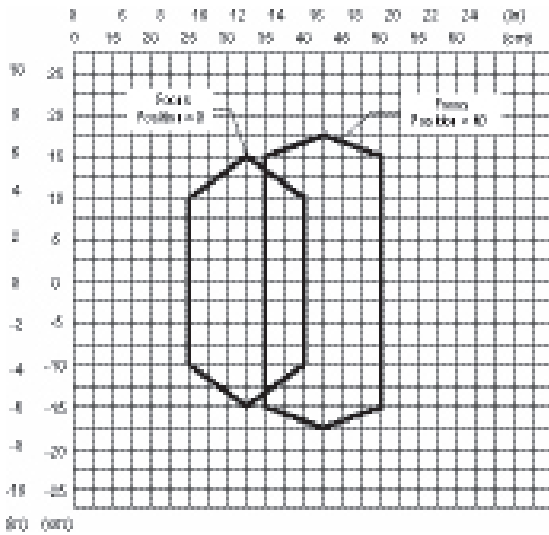

CONDITIONS
Code = Interleaved 2/5 or Code 39
PCS = 0.90
Pitch angle = 0°
Skew angle = 10° - 20°
Tilt angle = 0

DS6300-105-0XX (Oscillating Mirror)
Resolution: 0.30 mm/12 mils

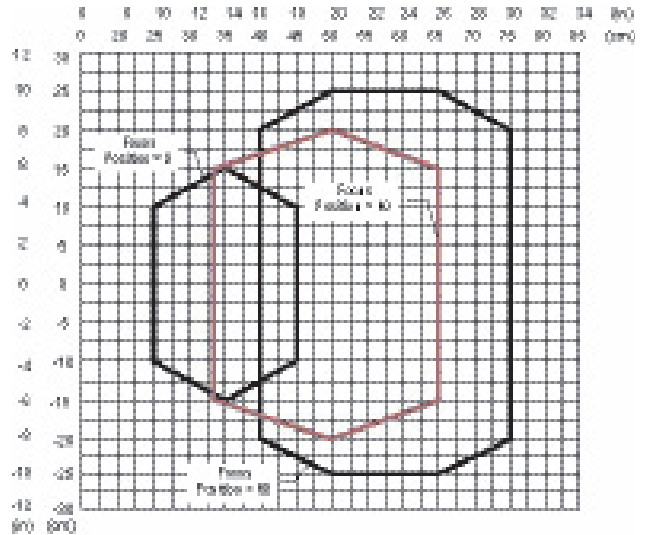

CONDITIONS
Code = Interleaved 2/5 or Code 39
PCS = 0.90
Pitch angle = 0°
Skew angle = 10° - 20°
Tilt angle = 0°

DS6300-105-0XX (Oscillating Mirror)
Resolution: 0.38 mm/15 mils

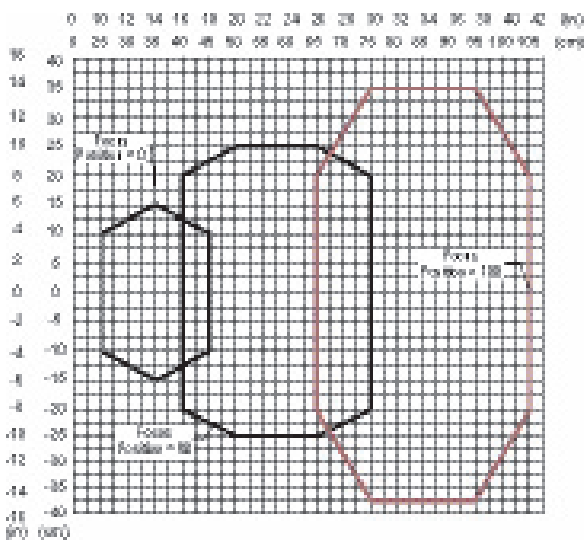

CONDITIONS
Code = Interleaved 2/5 or Code 39
PCS = 0.90
Pitch angle = 0°
Skew angle = 10° - 20°
Tilt angle = 0°

DS6300-105-0XX (Oscillating Mirror)
Resolution: 0.50 mm/20 mils

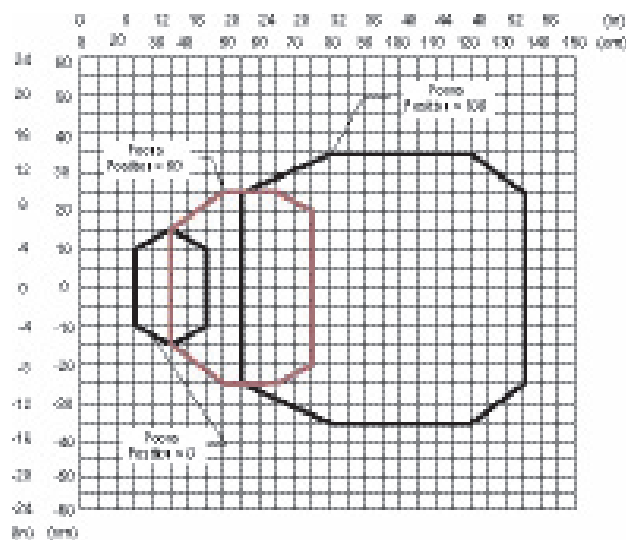

CONDITIONS
Code = Interleaved 2/5 or Code 39
PCS = 0.90
Pitch angle = 0°
Skew angle = 10° - 20°
Tilt angle = 0°

DIMENSIONS

OSCILLATING MIRROR VERSION

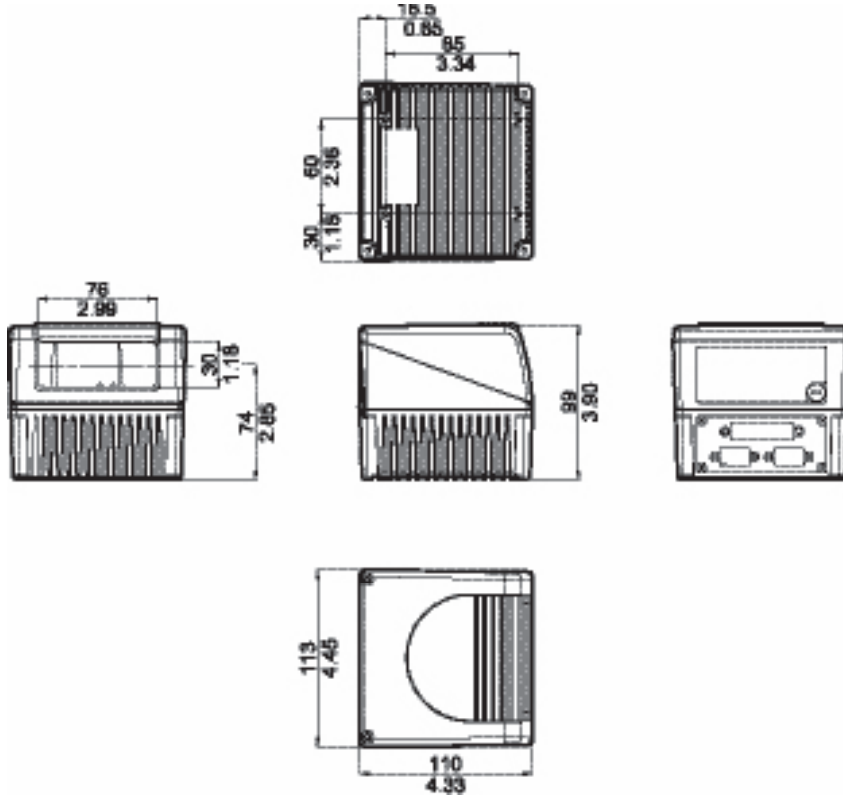

OSCILLATING MIRROR VERSION

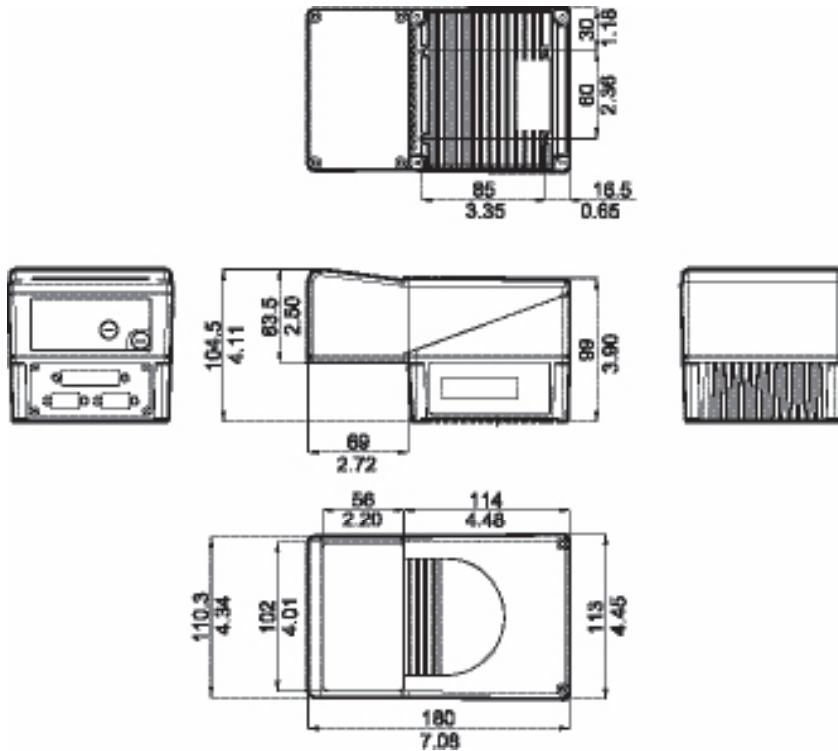

mm / inch

ELECTRICAL CONNECTIONS

All the connectors available for each DS6300 model are the following:

SCANNER MODEL	CONNECTORS
Master/Slave	25-pin male serial interface and I/O connector 9-pin male Lonworks connector* 9-pin female Lonworks connector
Ethernet	26-pin male serial interface and I/O connector 9-pin female Lonworks connector RJ45 modular connector

The DS6300 Master/Slave models are equipped with a 25-pin male D-sub connector for connection to the host computer, power supply and input/output signals. The DS6300 Ethernet models adopt a 26-pin male connector instead of the 25-pin one.

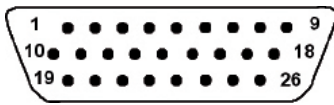

26-pin Connector

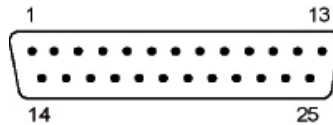

25-pin Connector

25-PIN D-SUB MALE CONNECTOR PINOUT				
Pin	Name	Function		
1	CHASSIS	Chassis - internally connected to GND Cable connected to chassis		
20	RXAUX	Receive data of auxiliary RS232 (referred to GND)		
21	TXAUX	Transmit data of auxiliary RS232 (referred to GND)		
8	OUT 1+	Configurable digital output 1 - positive pin		
22	OUT 1-	Configurable digital output 1 - negative pin		
11	OUT 2+	Configurable digital output 2 - positive pin		
12	OUT 2-	Configurable digital output 2 - negative pin		
16	OUT 3A	Configurable digital output 3 - polarity insensitive		
17	OUT 3B	Configurable digital output 3 - polarity insensitive		
18	EXT_TRIG/PS A	External trigger (polarity insensitive) for PS		
19	EXT_TRIG/PS B	External trigger (polarity insensitive) for PS		
6	IN 2/ENC A	Input signal 2 (polarity insensitive) for Encoder		
10	IN 2/ENC B	Input signal 2 (polarity insensitive) for Encoder		
14	IN 3A	Input signal 3 (polarity insensitive)		
15	IN 4A	Input signal 4 (polarity insensitive)		
24	IN_REF	Common reference of IN3 and IN4 (polarity insensitive)		
9,13	VS	Supply voltage - positive pin		
23,25,26	GND	Supply voltage - negative pin		
Pin	RS232	RS232	RS485 Full-Duplex	RS485 Half-Duplex
2	Main Interface Signals (SW Selectable)	TX	TX485 +	RTX485 +
3		RX	* RX485 +	
4		RTS	TX485 -	RTX485 -
5		CTS	* RX485 -	
7		GND_ISO	GND_ISO	GND_ISO

* Do not leave floating, see DS6300 Reference Manual for connection details.

ELECTRICAL CONNECTIONS

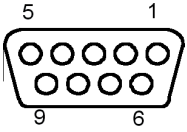

Female (all models)

9-pin Local Lonworks Connectors

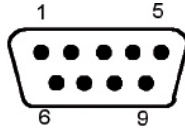

Male (Master/Slave model)

9-pin Local Lonworks Connectors

9-PIN LONWORKS CONNECTOR PINOUT

Pin	Name	Function
1	CHASSIS	Cable shield internally connected by capacitor to chassis
2	GND	Supply voltage - positive pin
6	VS_I/O	Supply voltage - negative pin
3	REF_I/O	Supply voltage of I/O circuit
4	SYS_ENC_I/O	Reference voltage of I/O circuit
5	SYS_I/O	System signal
7	LON A	System signal
8	LON B	Lonworks line (polarity insensitive)

In DS6300 Ethernet models a RJ45 Modular Jack is provided for Ethernet connection. This interface and the connector pinout are IEEE 802.3 10 BaseT and IEEE 802.3u 100 BaseTX compliant.

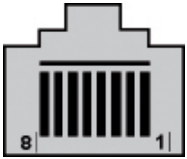

RJ45 Modular Jack

RJ45 MODULAR JACK PINOUT

Pin	Name	Function
1	TX +	Transmitted data (+)
2	TX -	Transmitted data (-)
3	RX +	Received data (+)
6	RX -	Received data (-)
4,5,7,8	NC	Not connected

MODELS AND ACCESSORIES

MODELS	
Order No.	Description
931351010	DS6300-100-010 ADJ FOCUS, LINEAR, M/S
931351020	DS6300-100-011 ADJ FOCUS, LINEAR, PROFIBUS
931351030	DS6300-100-012 ADJ FOCUS, LINEAR, ETHERNET
931351040	DS6300-100-015 ADJ FOCUS, LINEAR, DEVICENET
931351060	DS6300-105-010 ADJ FOCUS, OSC. MIRROR, M/S
931351070	DS6300-105-011 ADJ FOCUS, OSC. MIRROR, PROFIBUS
931351080	DS6300-105-012 ADJ FOCUS, OSC. MIRROR, ETHERNET
931351090	DS6300-105-015 ADJ FOCUS, OSC. MIRROR, DEVICENET

ACCESSORIES	
Order No.	Description
93A201100	GFC-60 90° MIRROR
93A201102	GFC-600 90° MIRROR CLOSE DISTANCE
93ACC1730	GFX-60 X-PATTERN MIRROR
93ACC1721	FBK-6000 FAST BRACKET KIT (2 PCS)

TECHNICAL DATA

	DS6300-100-01X	DS6300-105-01X
DIMENSIONS	110 x 113 x 99 mm (4.33 x 4.45 x 3.9 in)	113 x 180 x 104.5 mm (4.45 x 7.08 x 4.11 in)
WEIGHT	1.5 kg. (3.3 lb)	2.0 kg. (4.4 lb)
CASE MATERIAL	Aluminum	
OPERATING TEMPERATURE	0 to 40 °C (32 to 104 °F),	
STORAGE TEMPERATURE	-20 to 70 °C (-4 to 158 °F)	
HUMIDITY	90% non condensing	
VIBRATION RESISTANCE	IEC 68-2-6 test FC 1.5mm; 10 to 55 Hz; 2 hours on each axis	
SHOCK RESISTANCE	IEC 68-2-27 test EA 30 G; 11 ms; 3 shocks on each axis	
PROTECTION CLASS	IP64 for standard models; IP65 on request	
LIGHT SOURCE	Visible laser diode (630 to 680 nm)	
SCANNING SPEED	600 to 1200 scan/s SW programmable	
RESOLUTION	Down to 0.20 mm (8 mils)	
READABLE SYMBOLOGIES	Code 2/5, Code39, Code93, Code128, EAN/UPC, EAN128, Codabar, Pharmacode, ISBN128	
MULTILABEL READING	Up to 10 different symbologies during the same reading phase	
COMMUNICATION INTERFACES	Main Port: RS232/RS485 up to 115.2 Kbit/s	
	Auxiliary Port: RS232 up to 115.2 Kbit/s	
OTHER AVAILABLE INTERFACES	Lonworks (Master/Slave), Ethernet, Profibus, DeviceNet	
DIGITAL INPUTS	Four SW programmable, optocoupled, NPN/PNP	
DIGITAL OUTPUTS	Three SW programmable, optocoupled, event driven	
DISPLAY & KEYPAD	LCD 16 x 2 characters & 3 keys	
LED INDICATORS	Power On, Phase On, Data Tx	
DEVICE PROGRAMMING	Windows™ based SW (Genius™) via serial or Ethernet link	
	Serial Host Mode Programming sequences	
OPERATING MODES	'On-line', 'Serial On-line', 'Automatic', 'Continuous', 'Test'	
LASER CLASSIFICATION	Class 2 - EN60825-1; Class II - CDRH	
LASER CONTROL	Safety system to turn laser off in cases of motor slowdown or failure	
POWER SUPPLY	15 to 30 VDC	
POWER CONSUMPTION	15 W typical, 20 W max	